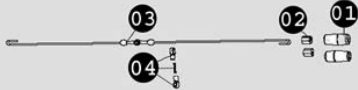
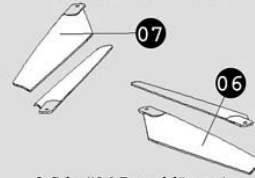

001-151 Stabiset

- 2 Stk. #01 Gummimantel
- 2 Stk. #02 Stabi-Gewicht
- 1 Stk. #03 Stabi-Stange
- 1 Stk. #04 Anlenkgestänge

001-152 Blatthalterset

- 4 Stk. #05 Blatthalter

001-153 Rotorblattset

- 2 Stk. #06 Rotorblätter A
- 2 Stk. #07 Rotorblätter B

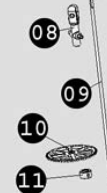
001-154 Wellenset oben

- 1 Stk. #08 Zentralstück oben
- 1 Stk. #09 Welle oben/innen
- 1 Stk. #10 Zahnrad
- 1 Stk. #11 Stellring

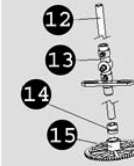
001-155 Wellenset unten

- 1 Stk. #12 Welle unten/aussen
- 1 Stk. #13 Zentralstück unten
- 1 Stk. #14 Paßhülse
- 1 Stk. #15 Zahnrad

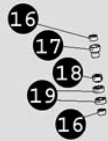
001-156 Lagerset

- 2 Stk. #16 Lager 2x6x3
- 1 Stk. #17 Lagersitz
- 1 Stk. #18 Stellring
- 2 Stk. #19 Lager 4x8x3

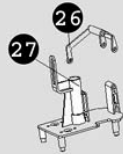
001-157 Rahmenset

- 1 Stk. #26 Rumpfbock
- 1 Stk. #27 Hauptrahmen

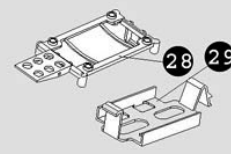
001-158 Halterset

- 1 Stk. #28 Rahmen
- 1 Stk. #29 Akkuhalter

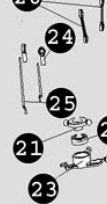
001-159 Taumelscheibenset

- 2 Stk. #20 Doppelgelenk
- 1 Stk. #21 TS-Innenring
- 1 Stk. #22 Lager 7x13x4
- 1 Stk. #23 TS-Aussenring
- 2 Stk. #24 Kugelgelenke
- 2 Stk. #25 Servogestänge

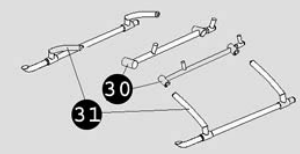
001-160 Kufenset

- 2 Stk. #30 Kufenhalter
- 2 Stk. #31 Kufenbügel

001-161 Motorset

- 1 Stk. #32 Motor links
- 1 Stk. #33 Motor rechts

Onboardelektronik

- 001-524 OBE 2,4 GHz
- 001-535 OBE 35 MHz
- 001-540 OBE 40 MHz
- 001-572 OBE 72 MHz

001-035 Akku

- 1 Stk. #35 Akku 7,4V 800mAh Lipo

001-036 Servo

- 1 Stk. #36 Servo

001-162 Schraubenset

- 1 Set #42 Schrauben

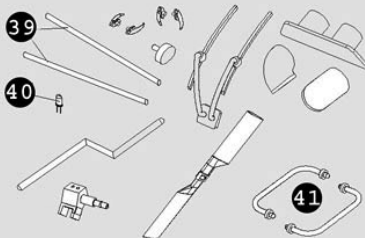
001-163 Beschlagteile Set

- 2 Stk. #39 Stäbe
- 1 Stk. #40 LED
- 1 Set #41 Beschlagsatz:
- 1 Stk. Scheibenwischer
- 3 Stk. Turbinenattrappe
- 2 Stk. VOR-Antennen
- 1 Stk. Heckrotorgetriebe
- 1 Stk. Hecksporn
- 1 Stk. Tankkappe
- 4 Stk. Türgriffe

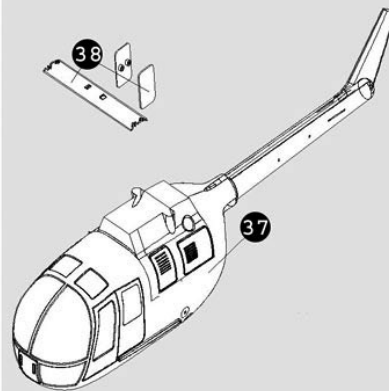
001-164 Rumpfset

- 1 Stk. #37 Rumpf lackiert
- 1 Set #38 Höhenleitwerk

4-Kanal FM Handsender

- | | |
|--------------------|--------------------|
| Mode 1 | Mode 2 |
| 001-624 TM 2,4 GHz | 001-724 TM 2,4 GHz |
| 001-635 TM 35 MHz | 001-735 TM 35 MHz |
| 001-640 TM 40 MHz | 001-740 TM 40 MHz |
| 001-672 TM 72 MHz | 001-772 TM 72 MHz |

001-065 Netzteil: 230V (Europa)

- 1 Stk. #44 Netzteil 230V

001-066 Automatikladeteil: 2s Lipo

- 1 Stk. #45 Ladeteil 2s Lipo

Mini
BO-105

Ersatzteilpakete

FWHelicopter